

Shroud Type	Shroud Model Number	Collar Diameter	Minimum Groove Height Required
Cutting Shrouds	D1730	1 1/2" – 2 3/16"	9/32"
	D1750	1 7/8" – 3"	9/32"
Grinding Shrouds	D0835, D1805, D1835, D5835	1 1/2" – 2 3/16"	1/4"
	D0850, D1807, D1850, D5850	1 7/8" – 3"	1/4"
	D1836, D1840	1 11/16" – 2 3/16"	N/A
	D1854	2 1/16" – 2 13/16"	N/A

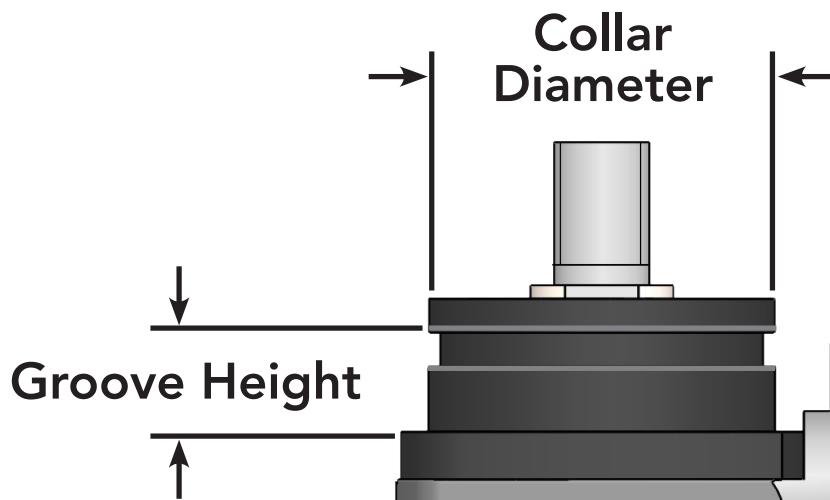

Note that the groove height measurement is taken from the **top** edge of the groove.